

Hygienic Urin Sampling | Instruction for female patients

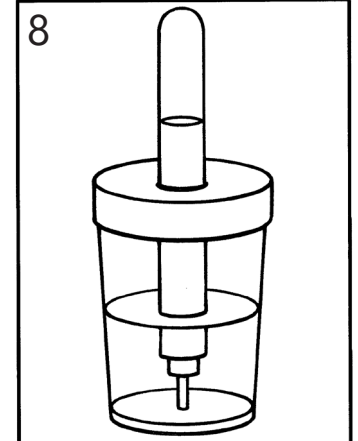

Hygienic Urin Sampling | Instruction for male patients

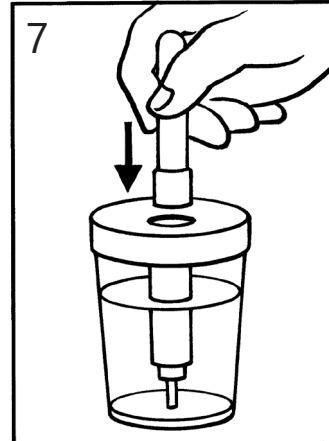
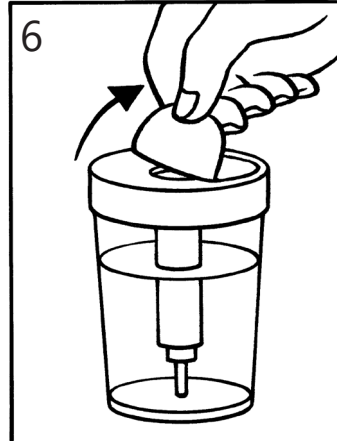
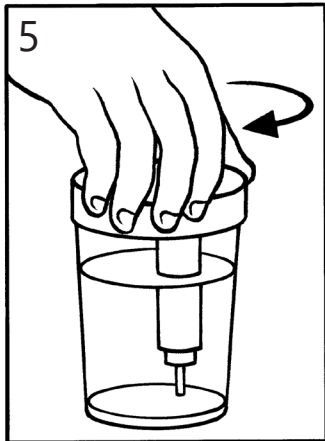
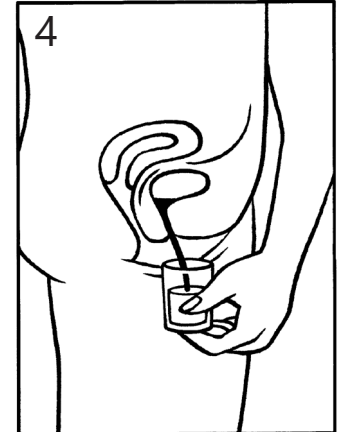
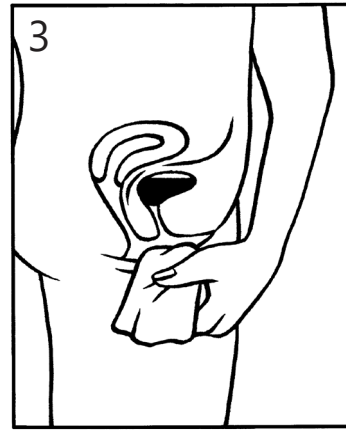
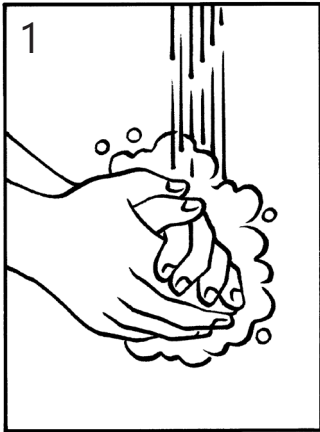